

Features

- Traditional styling coordinates with many faucet designs.
- Easy operation with one-touch spray actuation.
- Enhanced ergonomics and maneuverability with balljoint technology.
- MasterClean™ sprayface features an easy-to-clean surface that withstands mineral buildup.
- Includes nylon hose and sidespray holder.
- Deep rough-in kit available [1030920].

Recommended Products/Accessories

K-23723 Faucet cleaner

Optional Products/Accessories

1030920 Side Spray Deep Rough-In



Codes/Standards

ASME A112.18.1/CSA B125.1

NSF/ANSI 61

NSF/ANSI 372







All applicable US Federal and State material regulations

KOHLER® Faucet Lifetime Limited Warranty

See website for detailed warranty information.

Available Colors/Finishes

Color tiles intended for reference only.

Color	Code	Description
	CP	Polished Chrome
	AF	Vibrant® French Gold
	PB	Vibrant® Polished Brass
	BN	Vibrant® Brushed Nickel
	BV	Vibrant® Brushed Bronze
	2BZ	Oil-Rubbed Bronze

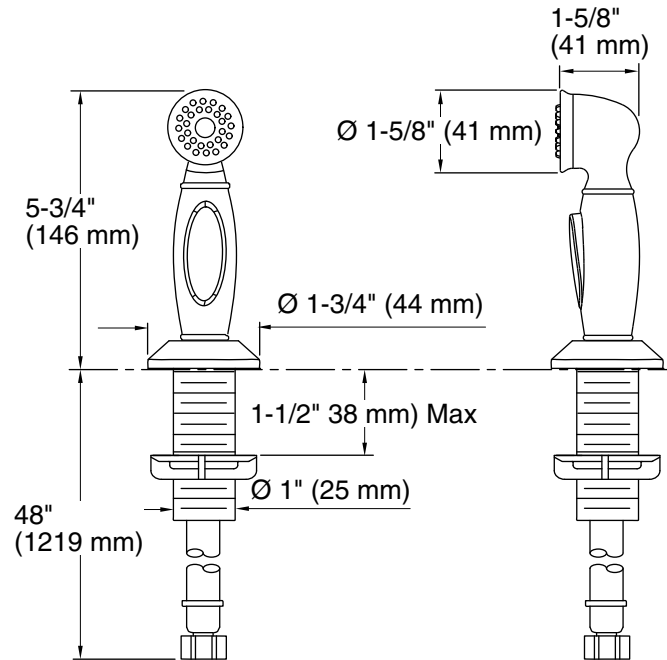
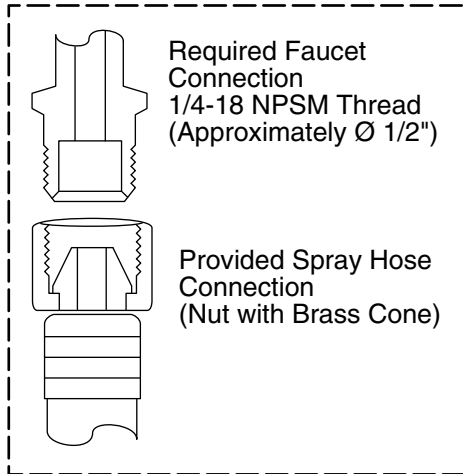

Technical Information

All product dimensions are nominal.

Drain included: No

Notes

Install this product according to the installation guide.